

750-806

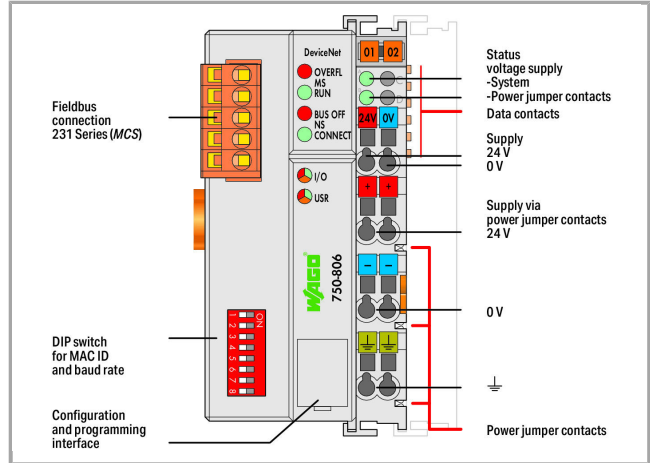
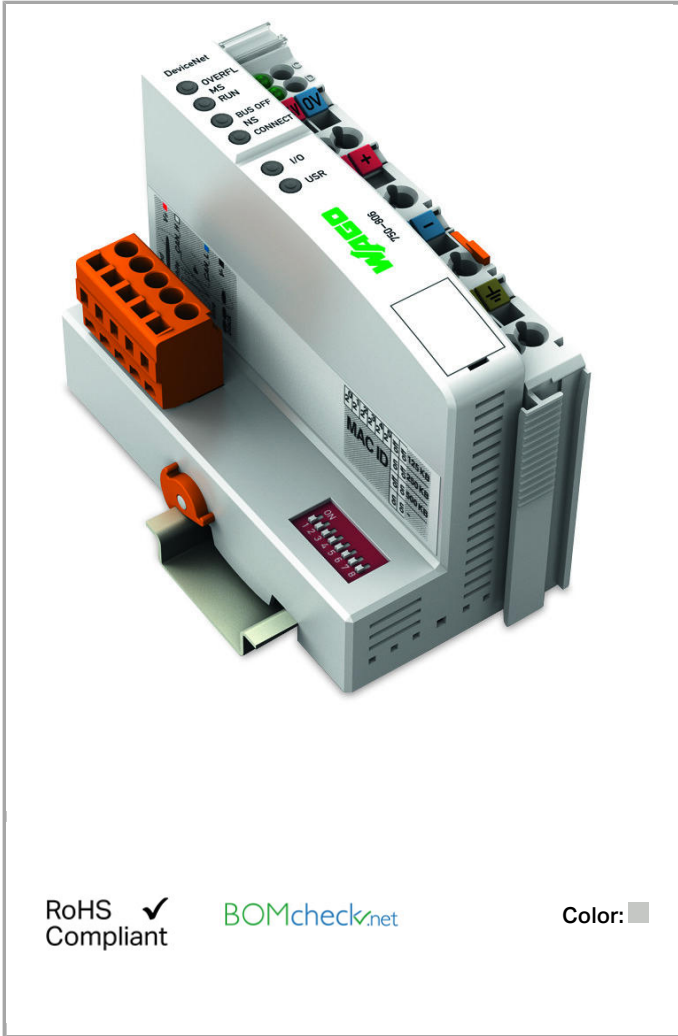

RoHS Compliant

BOMcheck.net

Color:

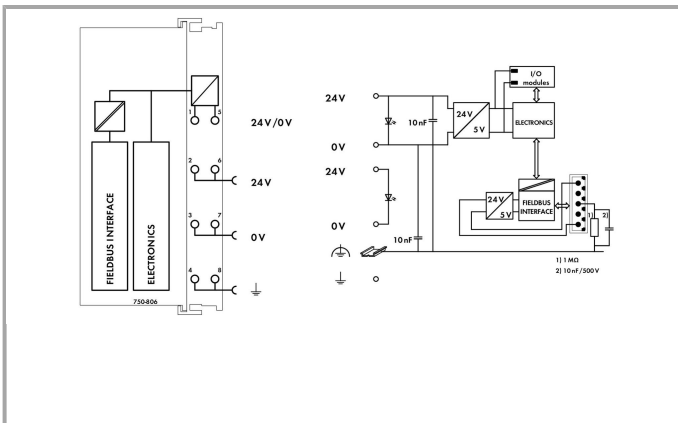

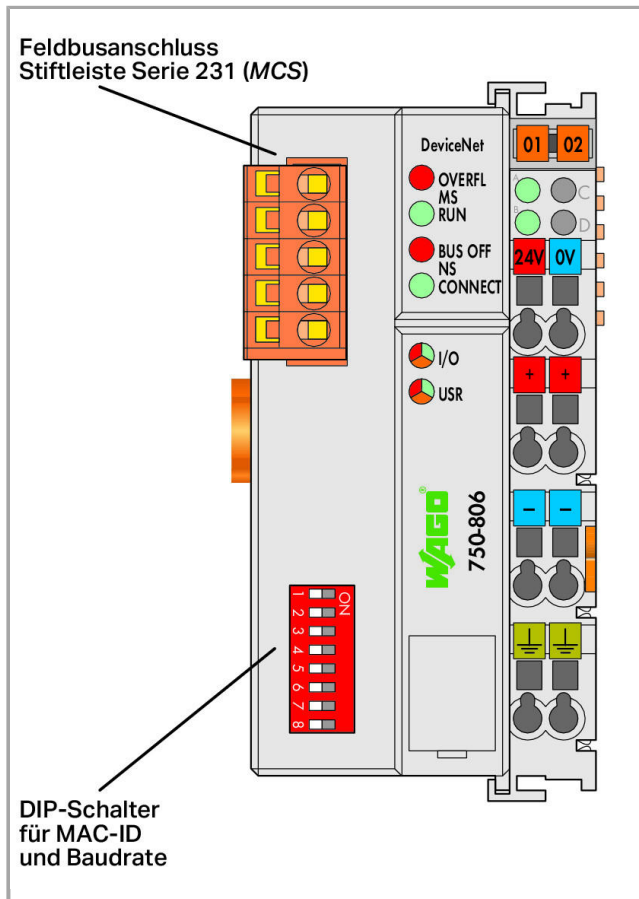

Item description

The DeviceNet Controller combines control functionality, I/O interface and fieldbus in one device.

Application programming is IEC 61131-3 compliant.

The programmer can access all fieldbus and I/O data.

Features and applications:

- Decentralized control to optimize support for a PLC or PC
- Divide complex applications into individually testable units
- Programmable fault response in the event of fieldbus failure
- Signal pre-processing to reduce fieldbus transmissions
- Directly control peripheral equipment for faster system response times
- Stand-alone, compact controller

Note:

Note: Configuration files required (EDS)!

The EDS files can be downloaded for free at www.wago.com.



Data

Technical Data

Communication	DeviceNet
Visualization	without
CPU	16 bits
Programming languages per IEC 61131-3	Instruction List (IL) Ladder Diagram (LD) Function Block Diagram (FBD), Continuous Function Chart (CFC) Structured Text (ST) Sequential Function Chart (SFC)
Programming environment	WAGO-I/O-PRO V2.3 (based on CODESYS V2.3)
Configuration options	Device description file EDS WAGO-I/O-CHECK
Cycle time	< 3 ms for 1,000 statements / 256 dig. I/Os
Baud rate	500 kBd (125 Kbaud, 250 Kbaud, 500 Kbaud)
Fieldbus segment length max.	500 m
Transmission medium (communication/fieldbus)	Shielded Cu cable Trunk line: 2 x 0.82 mm ² + 2 x 1.7 mm ² Drop line: 2 x 0.2 mm ² + 2 x 0.32 mm ²
Number of fieldbus nodes on the master max.	64
Max. no. of I/O points	6000
Program memory	128 kByte
Data memory	64 kByte
Software non-volatile memory	8 Kbytes
Memory for fieldbus input variables max.	512 Byte
Memory for fieldbus output variables max.	512 Byte
Number of modules per node max.	64
Input and output process image (Fieldbus) max.	1024 Byte/1024 Byte
DeviceNet features	Polled I/O message connection Strobed I/O message connection Change of state Cyclic message connection UCMM DeviceNet master can be programmed using function blocks
Indicators	LED (OVERF) red: device error; LED (RUN) green: Device status; LED (BUS OFF) red: Network error ; LED (CONNECT) green: Network status; LED (I/O, USR) red/green/orange: Internal data bus status, status programmable by user; LED (A, B) green: System power supply status, field supply
System supply voltage	DC 24 V(-25 ... +30 %); via wiring level (CAGE CLAMP [®] connection)
Input current via DeviceNet interface at 11 V	120 mA
Input current typ. at rated load (24 V)	500 mA
Efficiency of the power supply (typ.) at nominal load (24 V)	87 %
Current consumption, system supply (5 V)	350 mA

Total current for system supply	1650 mA
Field supply voltage	DC 24 V (-25 ... +30 %); via power jumper contacts
Current carrying capacity of the power jumper contacts	10 A
Number of outgoing power jumper contacts	3
Isolation	500 V system/supply

Connection data

Connection technology: communication/fieldbus	DeviceNet: 1 x 5-pole male connector
Connection technology: system supply	2 x CAGE CLAMP®
Connection technology: field supply	6 x CAGE CLAMP®
Connection type (1)	System/field supply
Solid conductor	0.08 ... 2.5 mm ² / 28 ... 14 AWG
Fine-stranded conductor	0.08 ... 2.5 mm ² / 28 ... 14 AWG
Strip length	8 ... 9 mm / 0.31 ... 0.35 inch
Connection technology: Device configuration	1 x 4-pole male connector

Geometrical Data

Width	50.5 mm / 1.988 inch
Height	71.1 mm / 2.799 inch
Height from upper-edge of DIN-35 rail	63.9 mm / 2.516 inch
Depth	100 mm / 3.937 inch

Mechanical data

Weight	200 g
Color	light gray
Housing material	Polycarbonate, polyamide 6.6
Conformity marking	1

Environmental Requirements

Surrounding air (operating) temperature	0 ... 55 °C
Surrounding air (storage) temperature	-40 ... 85 °C
Protection class	IP20
Degree of pollution (5)	2 per IEC 61131-2
Operating altitude	without temperature derating: 0 ... 2000 m; with temperature derating: 2000 ... 5000 m (0.5 K/100 m); max.: 5000 m
Relative air humidity (no condensation)	95 %
Mounting position	any
Type of mounting	DIN-35 rail
Vibration resistance	4g per IEC 60068-2-6
Shock resistance	15g per IEC 60068-2-27



EMC immunity to interference	acc. to EN 61000-6-2, marine applications
EMC emission of interference	acc. to EN 61000-6-4, marine applications
Exposure to pollutants	Per IEC 60068-2-42 and IEC 60068-2-43
Permissible H ₂ S contaminant concentration at a relative humidity 75 %	10 ppm
Permissible SO ₂ contaminant concentration at a relative humidity 75 %	25 ppm

Commercial data

Product Group	15 (Remote I/O)
Country of origin	DE
GTIN	4045454527020
Customs Tariff No.	85371091990

Approvals / Certificates

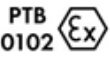
Ex-Approvals

Logo	Approval	Additional Approval Text	Certificate name
	ATEX TUEV Nord Cert GmbH	EN 60079-0	TÜV 07 ATEX 554086 X en.
	TUEV Nord TUEV Nord Cert GmbH	IEC 60079-0	IECEX TUN 09.0001 X

Country specific Approvals

Logo	Approval	Additional Approval Text	Certificate name
	KC National Radio Research Agency	Article 58-2, Clause 3	MSIP- REM-W43- PFC750

Ship Approvals

Logo	Approval	Additional Approval Text	Certificate name
	ABS American Bureau of Shipping	-	19- HG1821926
	BV Bureau Veritas S.A.	-	13453/DO BV

BUREAU
VERITAS

DNV GL
Det Norske Veritas, Germanischer Lloyd

-

TAA0000194



KR
Korean Register of Shipping

-

HMB05880-
AC001

LR
Lloyds Register

-

02/20026 (E5)



NK
Nippon Kaiji Kyokai

-

TA17255M



PRS
Polski Rejestr Statków

-

TE/2236
/880590/19

PRS
Polski Rejestr Statków

-

TE/1989
/880590/13

RINA
RINA Germany GmbH

-

ELE134212XG

UL-Approvals













Logo	Approval	Additional Approval Text	Certificate name
	UL UL International Netherlands B.V. (ORDINARY LOCATIONS)	UL 508	E175199 Sec.1

Compatible products



General accessories















	Item no.: 750-921 Bluetooth® Adapter	750-921
	Item no.: 750-923 Configuration cable; USB connector; Length: 2.5 m	750-923
	Item no.: 750-923/000-001 Configuration cable; USB connector; Length: 5 m	750-923 /000-001

















Carrier rail













	Item no.: 210-112 Steel carrier rail; 35 x 7.5 mm; 1 mm thick; 2 m long; slotted; according to EN 60715; "Hole width 25 mm	210-112
	Item no.: 210-113 Steel carrier rail; 35 x 7.5 mm; 1 mm thick; 2 m long; unslotted; according to EN 60715	210-113
	Item no.: 210-114 Steel carrier rail; 35 x 15 mm; 1.5 mm thick; 2 m long; unslotted; similar to EN 60715	210-114
	Item no.: 210-115 Steel carrier rail; 35 x 7.5 mm; 1 mm thick; 2 m long; slotted; according to EN 60715; "Hole width 18 mm	210-115
	Item no.: 210-118 Steel carrier rail; 35 x 15 mm; 2.3 mm thick; 2 m long; unslotted; according to EN 60715	210-118
	Item no.: 210-196 Aluminum carrier rail; 35 x 8.2 mm; 1.6 mm thick; 2 m long; unslotted; similar to EN 60715	210-196
	Item no.: 210-197 Steel carrier rail; 35 x 15 mm; 1.5 mm thick; 2 m long; slotted; similar to EN 60715	210-197
	Item no.: 210-198 Copper carrier rail; 35 x 15 mm; 2.3 mm thick; 2 m long; unslotted; according to EN 60715	210-198
	Item no.: 210-504 Steel carrier rail; 35 x 7.5 mm; 1 mm thick; 2 m long; slotted; galvanized; according to EN 60715	210-504
	Item no.: 210-505 Steel carrier rail; 35 x 7.5 mm; 1 mm thick; 2 m long; unslotted; galvanized; according to EN 60715	210-505
	Item no.: 210-506 Steel carrier rail; 35 x 15 mm; 1.5 mm thick; 2 m long; unslotted; galvanized; similar to EN 60715	210-506
	Item no.: 210-508 Steel carrier rail; 35 x 15 mm; 1.5 mm thick; 2 m long; slotted; galvanized; similar to EN 60715	210-508

Marking accessories

	Item no.: 2009-145 Mini-WSB Inline; for Smart Printer; on reel; stretchable 5 - 5.2 mm; plain; snap-on type	2009-145
	Item no.: 2009-145/000-002 Mini-WSB Inline; for Smart Printer; on reel; stretchable 5 - 5.2 mm; plain; snap-on type	2009-145 /000-002

	Item no.: 2009-145/000-005 Mini-WSB Inline; for Smart Printer; on reel; stretchable 5 - 5.2 mm; plain; snap-on type	/000-005	2009-145
	Item no.: 2009-145/000-006 Mini-WSB Inline; for Smart Printer; on reel; stretchable 5 - 5.2 mm; plain; snap-on type	/000-006	2009-145
	Item no.: 2009-145/000-007 Mini-WSB Inline; for Smart Printer; on reel; stretchable 5 - 5.2 mm; plain; snap-on type	/000-007	2009-145
	Item no.: 2009-145/000-012 Mini-WSB Inline; for Smart Printer; on reel; stretchable 5 - 5.2 mm; plain; snap-on type	/000-012	2009-145
	Item no.: 2009-145/000-023 Mini-WSB Inline; for smartPRINTER; on reel; stretchable 5 - 5.2 mm; plain; snap-on type	/000-023	2009-145
	Item no.: 2009-145/000-024 Mini-WSB Inline; for Smart Printer; on reel; stretchable 5 - 5.2 mm; plain; snap-on type	/000-024	2009-145
	Item no.: 248-501 Miniature WSB Quick marking system; plain; Marker width 5 mm; 10 strips with 10 markers per card		248-501
	Item no.: 248-501/000-002 Mini-WSB marking card; as card; not stretchable; plain; snap-on type	/000-002	248-501
	Item no.: 248-501/000-005 Mini-WSB marking card; as card; not stretchable; plain; snap-on type	/000-005	248-501
	Item no.: 248-501/000-006 Mini-WSB marking card; as card; not stretchable; plain; snap-on type	/000-006	248-501
	Item no.: 248-501/000-007 Mini-WSB marking card; as card; not stretchable; plain; snap-on type	/000-007	248-501
	Item no.: 248-501/000-012 Mini-WSB marking card; as card; not stretchable; plain; snap-on type	/000-012	248-501
	Item no.: 248-501/000-017 Mini-WSB marking card; as card; not stretchable; plain; snap-on type	/000-017	248-501
	Item no.: 248-501/000-023 Mini-WSB marking card; as card; not stretchable; plain; snap-on type	/000-023	248-501
	Item no.: 248-501/000-024 Mini-WSB marking card; as card; not stretchable; plain; snap-on type	/000-024	248-501

	Item no.: 750-100 Marker card; as a DIN A4 sheet; plain	750-100
	Item no.: 750-103 Group marker carrier	750-103
	Item no.: 750-106 Group marker carrier	750-106
software		
	Item no.: 759-333 WAGO-I/O-PRO	759-333
	Item no.: 759-333/000-923 WAGO-I/O-PRO; USB-Set	759-333 /000-923
	Item no.: 759-911 WAGO-I/O-PRO; CD	759-911
shield connection		
	Item no.: 790-108 Shield clamping saddle; 11 mm wide; diameter of compatible conductor	790-108
	Item no.: 790-116 Shield clamping saddle; 19 mm wide; diameter of compatible conductor; 7 ... 16 mm	790-116
	Item no.: 790-124 Shield clamping saddle; 27 mm wide; diameter of compatible conductor; 6 ... 24 mm	790-124
	Item no.: 790-140 Shield clamping saddle; diameter of compatible conductor	790-140
	Item no.: 790-208 Shield clamping saddle; 12.4 mm wide; 3 ... 8 mm	790-208
	Item no.: 790-216 Shield clamping saddle; 21.8 mm wide; 6 ... 16 mm	790-216
	Item no.: 790-220 Shield clamping saddle; 30 mm wide; 6 ... 20 mm	790-220
system box		
	Item no.: 850-804 IP65 enclosure; Stainless steel; WxHxD (400x123x200 mm); 4 x M20, 16 x M16, 28 x M12 cable grip	850-804
	Item no.: 850-804/000-001 IP65 enclosure; Stainless steel; WxHxD (400x123x200 mm); 2 x M20, 13 x M16, 32 x M12 cable grip	850-804 /000-001
	Item no.: 850-805 IP65 enclosure; Stainless steel; WxHxD (600x123x200 mm); 4 x M20, 19 x M16, 67 x M12 cable grip	850-805
	Item no.: 850-814/002-000 IP65 enclosure; Sheet steel (RAL 7035); WxHxD (200x120x200 mm); without flange plate	850-814 /002-000

	Item no.: 850-815/002-000 IP65 enclosure; Sheet steel (RAL 7035); WxHxD (300x120x200 mm); without flange plate	850-815	7002-000
	Item no.: 850-816/002-000 IP65 enclosure; Sheet steel (RAL 7035); WxHxD (400x120x200 mm); without flange plate	850-816	7002-000
	Item no.: 850-817/002-000 IP65 enclosure; Sheet steel (RAL 7035); WxHxD (600x120x200 mm); without flange plate	850-817	7002-000
	Item no.: 850-825 IP65 enclosure; Aluminium (RAL 7032); WxHxD (160x100x160 mm); 9 x M12, 4 x M20	850-825	
	Item no.: 850-826 IP65 enclosure; Aluminium (RAL 7032); WxHxD (240x100x160 mm); 4 x M20, 4 x M16, 14 x M12 cable grip	850-826	
	Item no.: 850-826/002-000 IP65 enclosure; Aluminium (RAL 7035); WxHxD (240x100x160 mm); 4 x M20, 4 x M16, 14 x M12 cable grip	850-826	7002-000
	Item no.: 850-827 IP65 enclosure; Aluminium (RAL 7032); WxHxD (320x100x160 mm); 4 x M20, 8 x M16, 17 x M12 cable grip	850-827	
	Item no.: 850-827/002-000 IP65 enclosure; Aluminium (RAL 7035); WxHxD (320x100x160 mm); 4 x M20, 8 x M16, 17 x M12 cable grip	850-827	7002-000
	Item no.: 850-828 IP65 enclosure; Aluminium (RAL 7032); WxHxD (480x100x160 mm); 4 x M20, 10 x M16, 35 x M12 cable grip	850-828	
	Item no.: 850-828/002-000 IP65 enclosure; Aluminium (RAL 7035); WxHxD (480x100x160 mm); 4 x M20, 10 x M16, 35 x M12 cable grip	850-828	7002-000
	Item no.: 850-834 IP65 enclosure; Polyester (RAL 7032); WxHxD (164x100x164 mm); 9 x M12, 4 x M20	850-834	
	Item no.: 850-835 IP65 enclosure; Polyester (RAL 7032); WxHxD (244x100x164 mm); 4 x M20, 4 x M16, 14 x M12 cable grip	850-835	
	Item no.: 850-836 IP65 enclosure; Polyester (RAL 7032); WxHxD (324x100x164 mm); 4 x M20, 8 x M16, 17 x M12 cable grip	850-836	

Downloads

Documentation

Manual

DeviceNet Programmable Fieldbus Controller 125 - 500 kBaud, digital and analog signals	V 2.0.1	pdf 6.0 MB	Download
---	---------	---------------	----------

Bid Text



750-806 IO, Controller	Oct 2, 2014	doc 33.8 kB	Download
---------------------------	-------------	----------------	----------

Additional Information

Disposal; Electrical and electronic equipment, Packaging	V 1.0.0	pdf 265.8 kB	Download
--	---------	-----------------	----------

System Description

750 Controller, General Product Information		pdf 621.9 kB	Download
---	--	-----------------	----------

Overview on WAGO-I/O-SYSTEM 750 approvals		pdf 780.2 kB	Download
---	--	-----------------	----------

Use in Hazardous Environments Term definition, marking and installation regulations	V 1.0.0	pdf 1.0 MB	Download
--	---------	---------------	----------

Design Notes Basic conditions and recommendations for higher operational safety	V 2.0.0	pdf 1.5 MB	Download
--	---------	---------------	----------

Engineering-Software

Configuration and Commissioning Software

WAGO-IO-PRO Demo-Version (759-912) / Serie 750, 758 und 762	2.3.9.55 Jul 3, 2015	zip 108.3 MB	Download
---	-------------------------	-----------------	----------

WAGO Extension Setting / 750 Series	2.0.2 Mar 9, 2011	zip 5.4 MB	Download
-------------------------------------	----------------------	---------------	----------

Runtime Software

Firmware

Firmware: 750-806 Controller DeviceNet	11 Oct 26, 2018	zip 418.2 kB	Download
--	--------------------	-----------------	----------

CAD/CAE - Smart Data

CAD data

3D Download 750-806		URL	Download
---------------------	--	-----	----------



Device Files

Device Description File

EDS for DeviceNet / 750, 752, 755 and 767 Series	10 Mar 25, 2011	zip 68.3 kB	Download
--	--------------------	----------------	----------

Device Driver

WAGO USB Service Cable Driver / 750 and 857 Series 759-923	6.5.3.0 Sep 10, 2014	zip 4.8 MB	Download
---	-------------------------	---------------	----------

Product family

Controller 750

[Learn more about the product family.](#)

[Show all products from the family](#)

Subject to changes.
